



Pali Design, Inc.

1525 Hymus Boul.
Dorval, QC
H9P-1J5 Canada
Phone: 1-514-421-0309





customerservice@pali-design.com

www.pali-design.com

Assembly Instructions

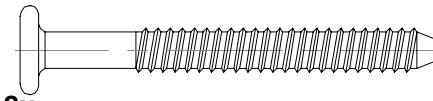
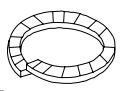
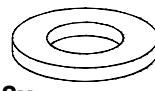
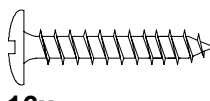
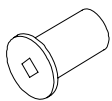
Novara Universal Rails

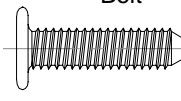
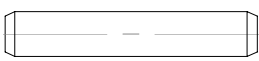
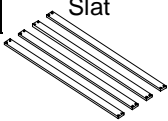
Hardware Parts List

A Allenhead Bolt  8x	B Lock Washer  8x	C Washer  8x	D Wood Screw  16x	E Cap Nut  2x
Universal Rail Parts List		P Allen Wrench  2x	H Allenhead Bolt  4x	J Metal Dowel  4x
F Slat  4x	G Universal Rail G1 G2  2x			

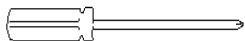
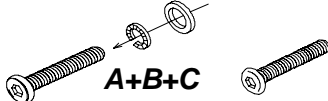
INSTRUCTION LEAFLET	Tools Needed for Assembly:	Hardware Preparation
Important, keep for future reference. Read carefully.		
Adult assembly is required		

CARE AND MAINTENANCE

Our beautiful crafted children's furniture is the result of four generations of craftsmanship and tradition. Each piece is created with as much attention and devotion as it was in our first workshop at our family home in 1919. The following care and maintenance recommendations will help to protect your Pali furniture investment:

- Sharp clothing articles like belt buckles and zippers will damage your furniture if they rub against it. Be particularly careful when you are close to the crib or dresser to avoid damaging your furniture.
- Avoid placing furniture directly under windows, in direct sunlight or in a damp area.
- Position your furniture away from heating or air conditioning vents.
- Use either a humidifier or de-humidifier as needed to keep the air in the room from becoming too dry or too damp.
- Dust your furniture frequently using a soft cloth to keep the build up of dirt to a minimum and help prevent scratches and ground-in grime.
- Only polish your furniture every 4-6 months and be sure to use polish that does not include silicone or wax that can damage the furniture finish.
- Do not place hot or extremely cold items directly onto the furniture surface as this can discolor the finish.

- Take care to lift your furniture when moving in order to prevent damage to the legs caused by pushing or dragging.
- When cleaning your crib, please use a non-toxic, non-abrasive cleaner. Mix a solution of water with a small amount of mild dishwashing liquid. Apply to crib surface with a soft, damp cloth lightly dampened in solution. After cleaning, dry completely with a soft, dry cloth.
- When storing crib use caution as extreme changes in temperature or humidity can compromise the crib making it extremely dangerous to your child.

Full-Size Bed **Step 1** **Transforming Crib into a Full-Size Bed**

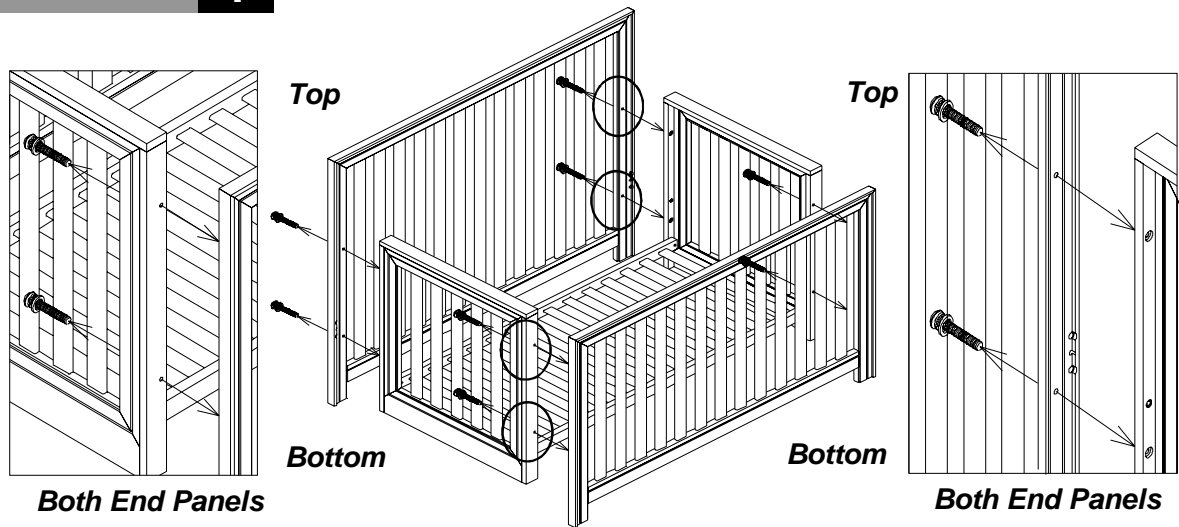

Full-Size Bed **Step 2** **Preparing Bed Rails**

Both Bed Rails (G1&G2)

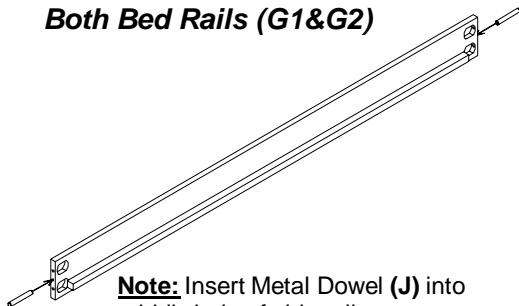

Note: Insert Metal Dowel (J) into middle hole of side rail.

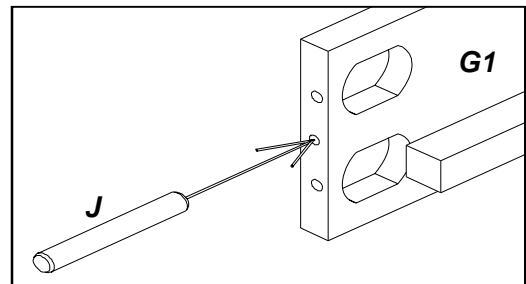

Cover Holes

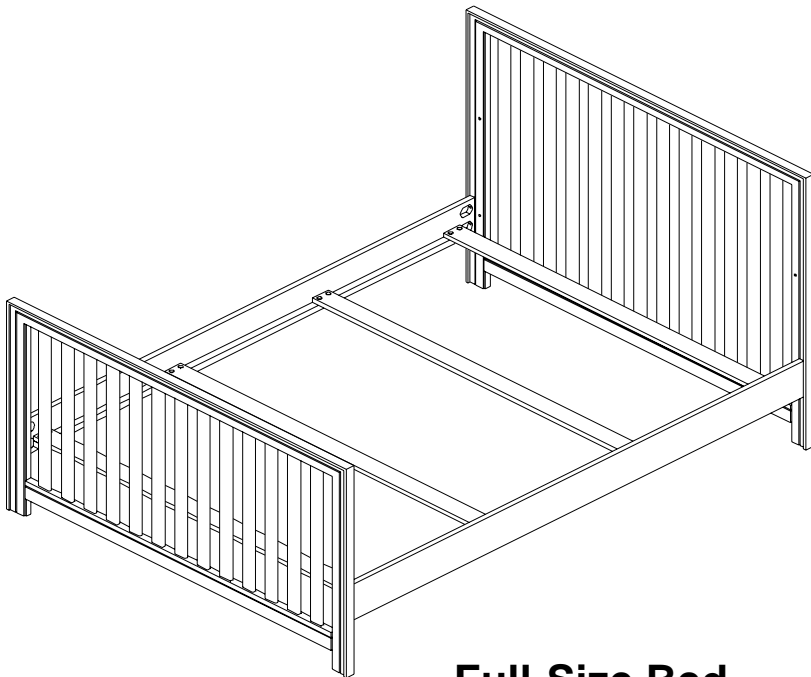
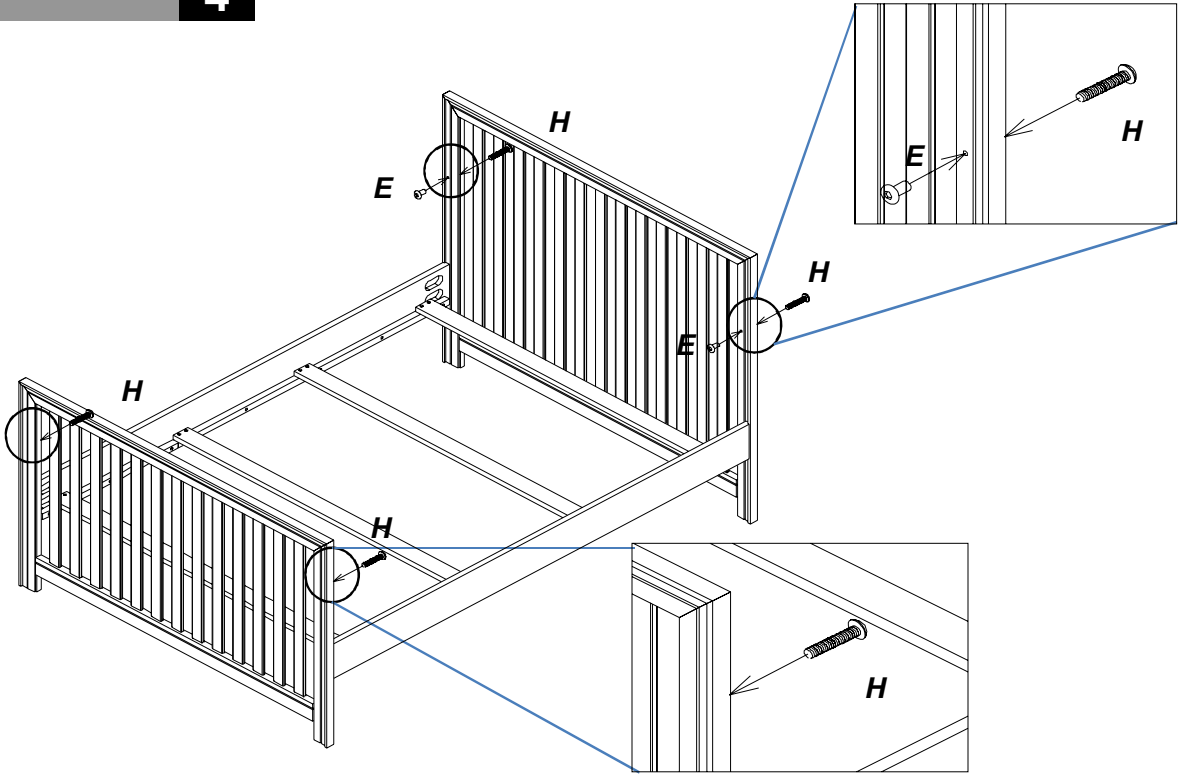

Full-Size Bed