



PALI spa  
 via Palmarina 115  
 33048 San Giovanni al Natisone  
 Udine Italy  
 tel. +39.432.756074  
 fax +39.432.757623  
 e-mail info@paliitaly.com  
 www.paliitaly.com

# DAUPHINE

This product is entirely made in Italy



**READ INSTRUCTIONS CAREFULLY  
 AND KEEP THIS SHEET  
 FOR FUTURE REFERENCE.**

## Metal drop side 1996-2000

### Care & Maintenance

Scuff marks may be removed with a damp cloth. Occasional use of furniture polish will maintain the good looks of your cot.

### For safety, please remember...

Periodically check all screw attachments to make sure they remain tight. A loose screw could injure a child or become a hook for necklaces causing a risk of strangulation. Do not attach any toy or decoration to the inside of the cot which could provide a foothold for your child to climb out. The safety of the cot could be adversely affected by using flammable bedding. The cot should not be used if any parts are lost or damaged.

**Be aware of the risk of open fire and other sources of high heat, such as electric bar fires, gas fires, etc, in the vicinity of the cot.** The assembly of this Pali crib is quite easy, but we still recommend that you follow the instructions closely to avoid any problems.

### PARTS LIST

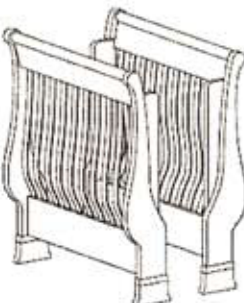

1 headboard  
1 footboard



2 side panels



1 spring (mattress base)

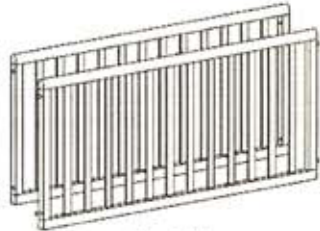

1 fixed side  
1 dropside



4 plastic covers



4 bolts 6x35



4 bolts 6x35



8 wooden pegs



1 small allen wrench



4 screws TN 6x50



1 wrench for TN 6x45 screws



1 large allen wrench



- 1 Lift
- 2 Push bottom rail
- 3 Lower

AS SOON AS BABY STARTS TO SIT UP YOU MUST USE THE LOWEST MATTRESS BASE POSITION.

To assemble the cot with the mattress base at HIGH position see step 4.



**THE MEDIUM BOLTS ON THE SIDE SUPPORTS SHOW THE MAXIMUM HEIGHT OF THE MATTRESS IN ITS HIGHEST POSITION.**

# Assembly instructions

Before assembling the crib, we recommend that, using the small allen wrench, you **LOOSEN** the three screws which fasten each crib side support to the headboards; it will then be easier to insert the two crib sides.

Leave all other screws slightly loosened while you assemble the crib; tighten them totally when finished.

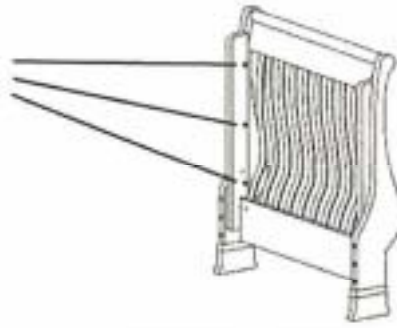

## STEP

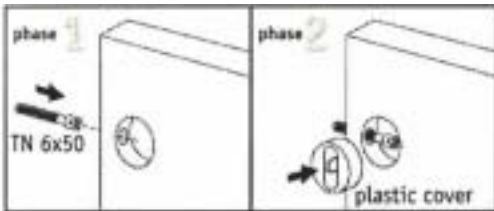

FIG. A1

Attach the two side rails to the headboard by inserting the wooden pegs into the facing holes (of the headboard and side rails) and then, after inserting the screws, cover the holes with the plastic cover and screw them in from the interior side of the side rails using the wrench. See Fig. A1 - A2.

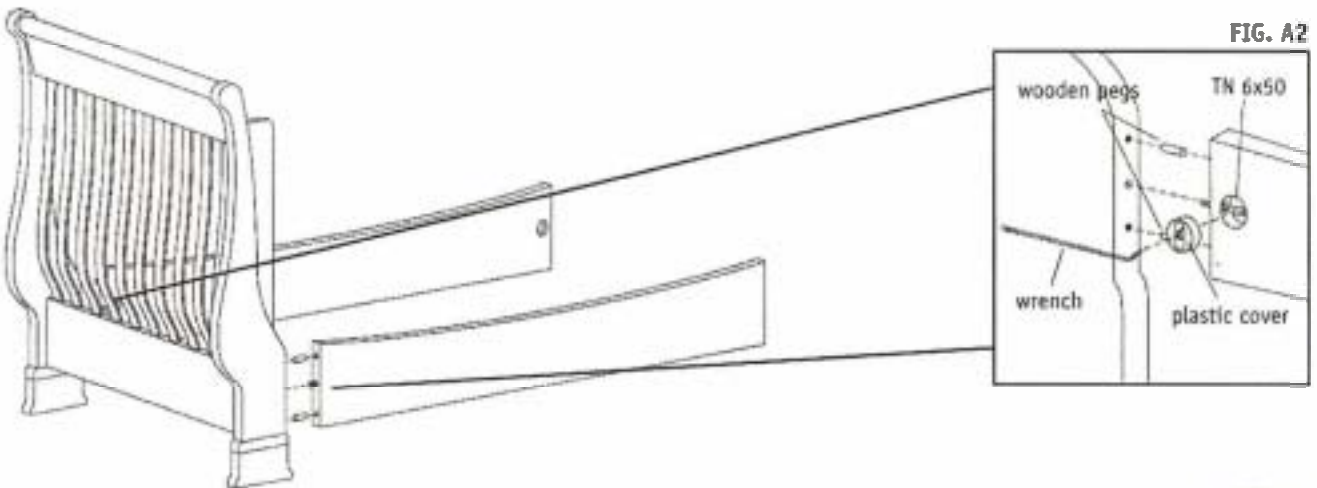
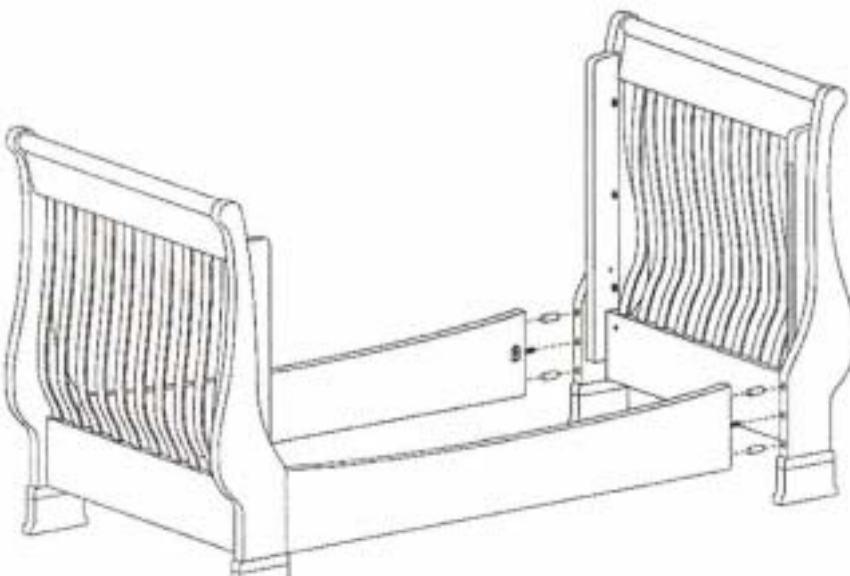

FIG. A2

## STEP 2



In the same way, attach the footboard to the two ends of the side rails. Now the principal frame of the bed is finished; make sure that the screws remain slightly loose.

Attaching the drop sides.

Position the fixed crib side between the two supports on the head- and footboards, corresponding to the appropriate holes; attach it with four 6x35 screws, as shown in Fig. B.

Now insert the crib drop side into the frame, from the bottom to the top: insert the two plastic dowels into the groove (Fig. C), then pull up on the drop side and slide the metal pins into the groove. After the drop side is correctly installed and you can raise and lower it, tighten all screws left loosened until now.

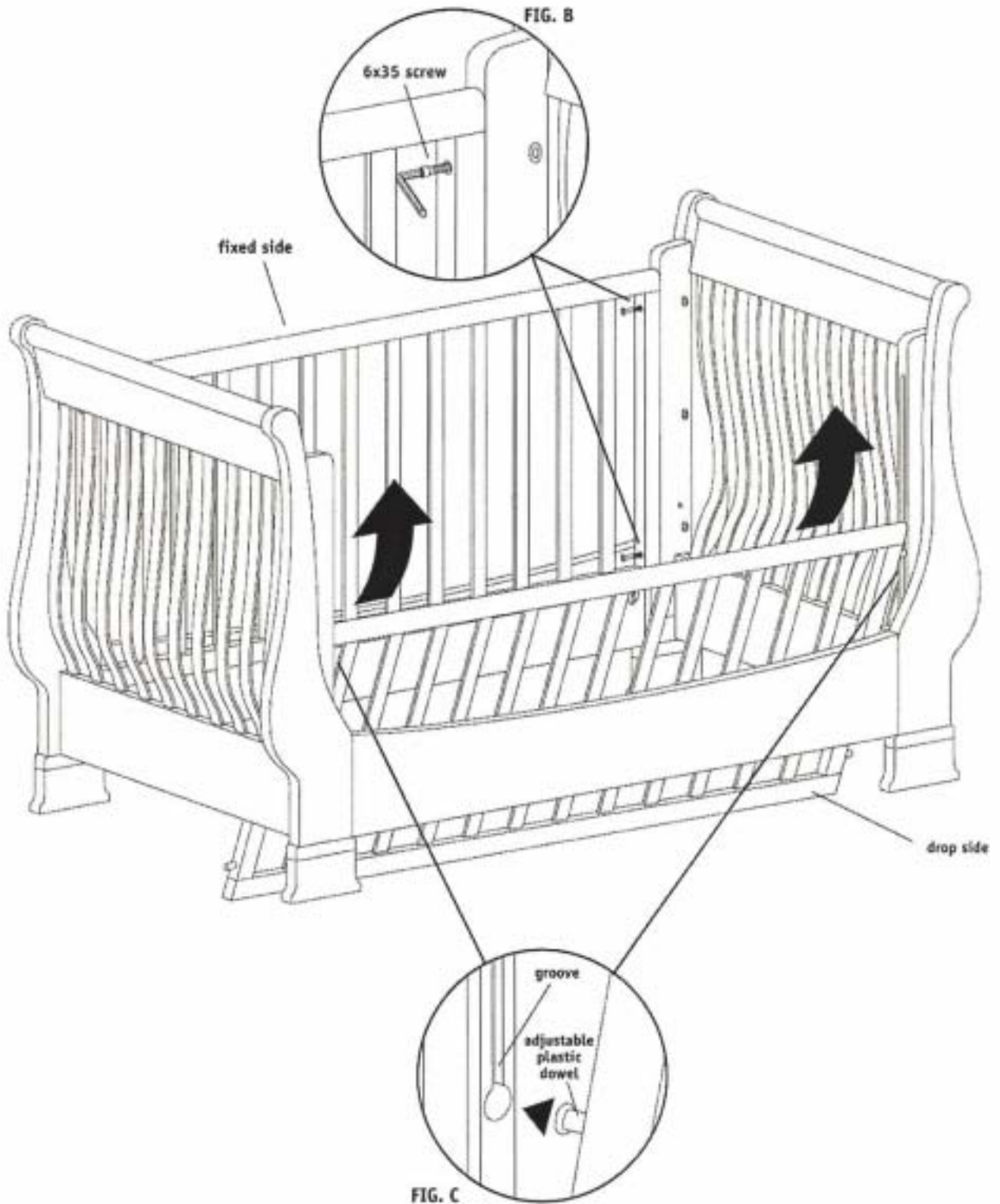

# STEP 4

Attaching the spring. Place the spring inside the frame of the crib and line it up with the lower holes of the head- and footboards; from the other side of the holes (on the inside of the spring) slide in four 6x35 bolts and screw them into the holes of the end.

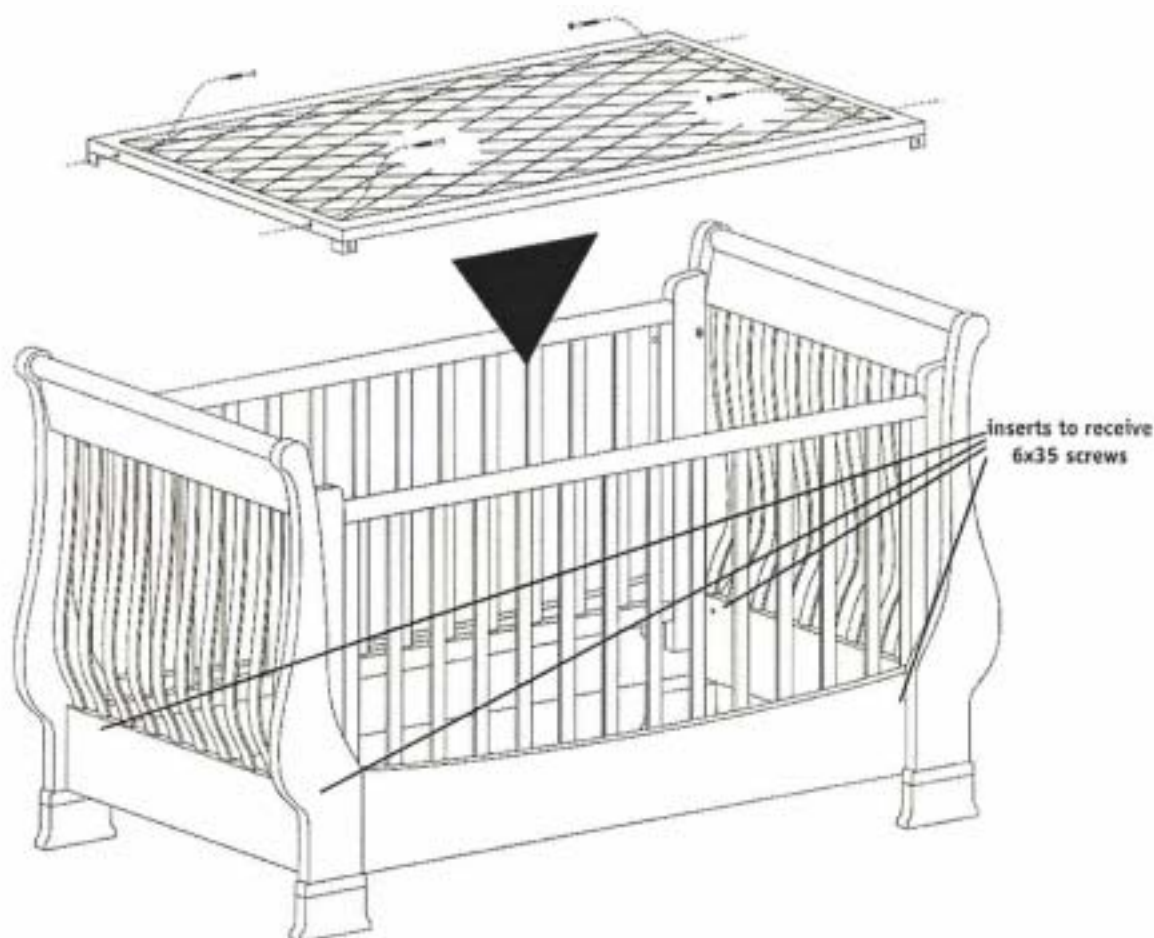

To use the spring in the high position, remove the four 6x35 bolts, raise the spring until it aligns with the four inserts on the crib side supports; then reinsert, from the inside of the spring, the four 6x35 bolts as shown on FIG. D.



**AS SOON AS BABY STARTS TO SIT UP,  
THE LOW POSITION MUST BE USED.  
THE DROPSIDE MUST BE RAISED WHEN BABY IS UNATTENDED.**

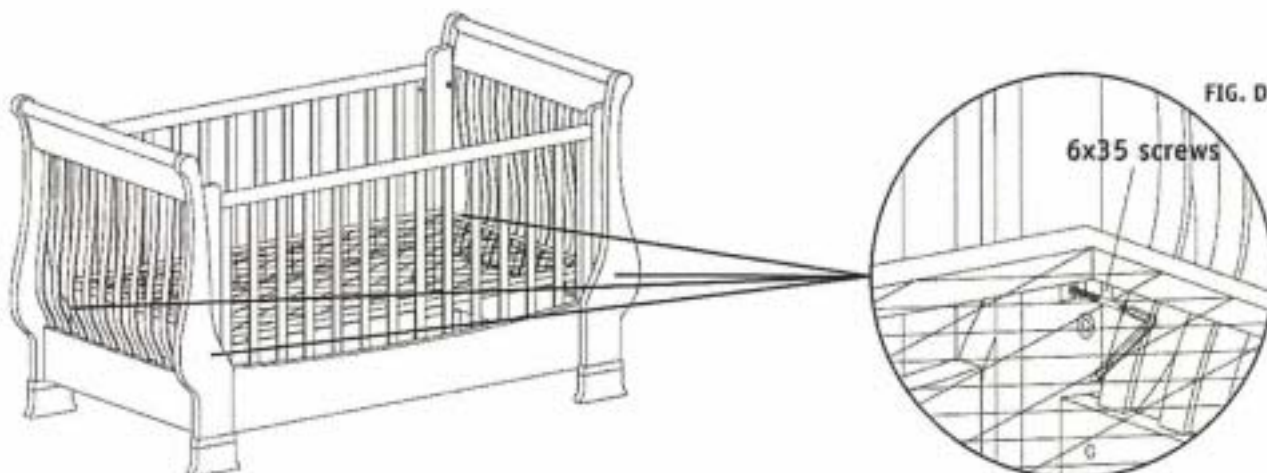

# Converting the crib to a sofa

In order to convert the crib to a sofa, follow this set of simple instructions.



THE FOLLOWING OPERATIONS  
REQUIRE THE HELP  
OF ANOTHER PERSON.

1 Carefully turn the junior bed onto its stationary side.

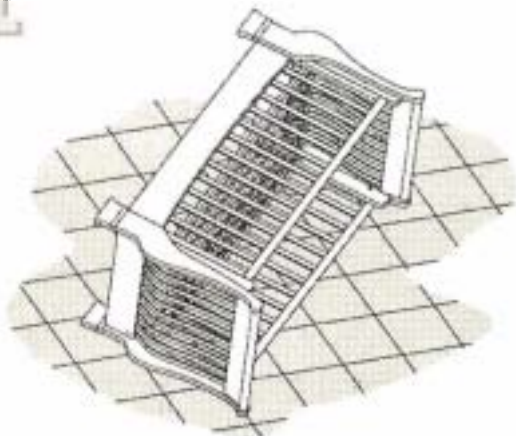

2 Remove the spring.

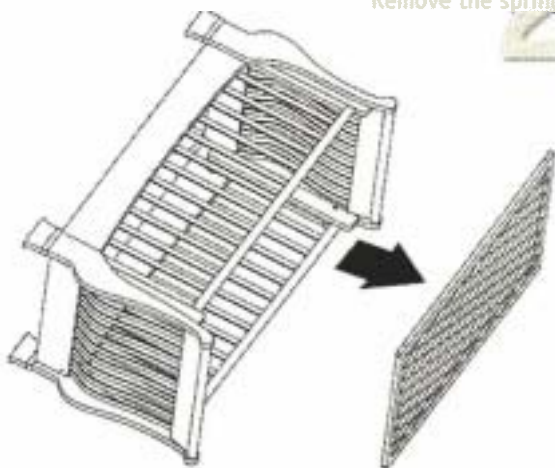

3 Remove the rail from the side with the dropside.

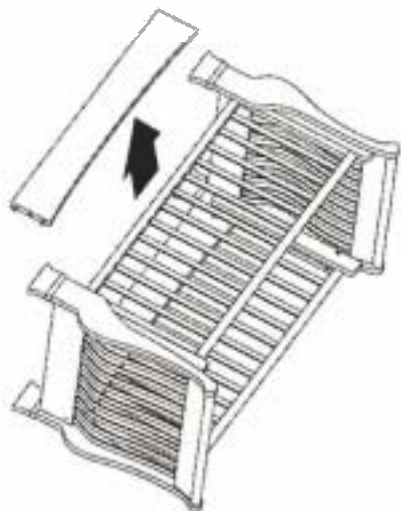

4 Remove the dropside.

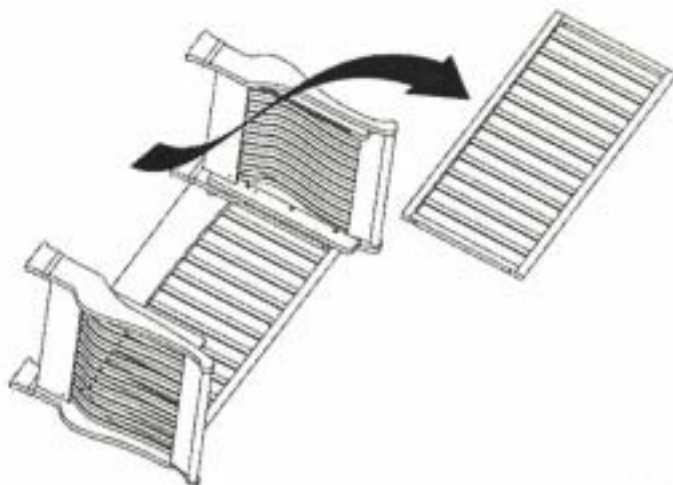

5 Replace the rail.

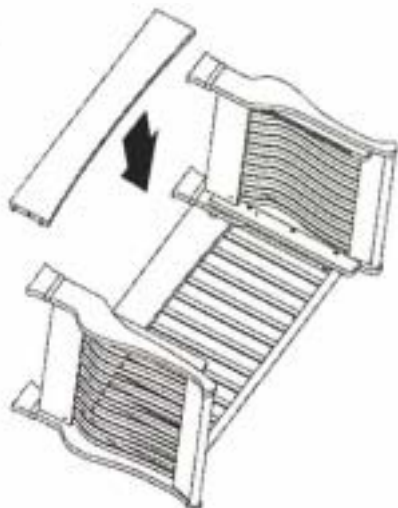

6 Remount the spring.

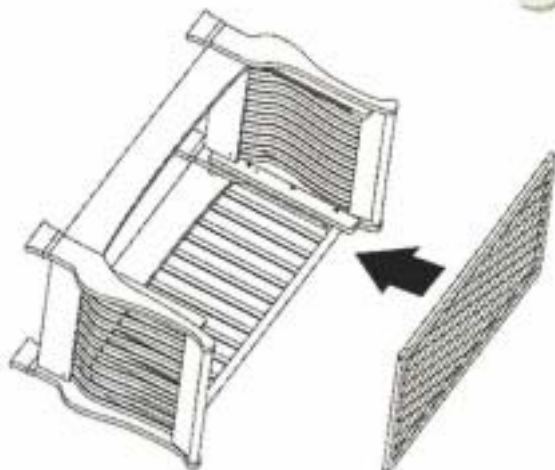

**7** Remove the dropside supports.

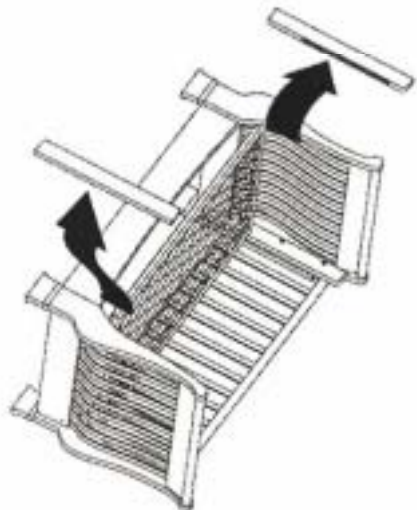

Now you can place the cushions on the sofa.



**USE THE SHORT BOLTS 6x10 TO COVER THE HOLES ON THE POSTS.**



## Converting the sofa to a junior bed

**1** Carefully turn the junior bed onto its empty side.

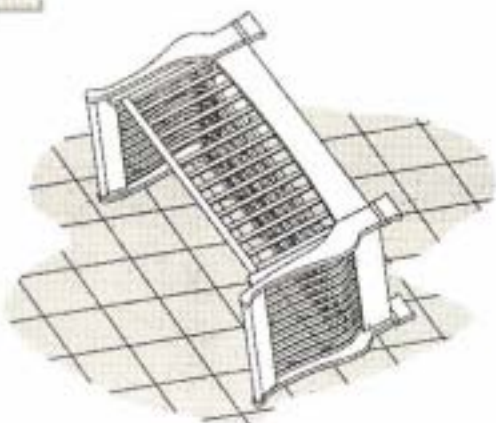

Remove the stationary side.

**2**

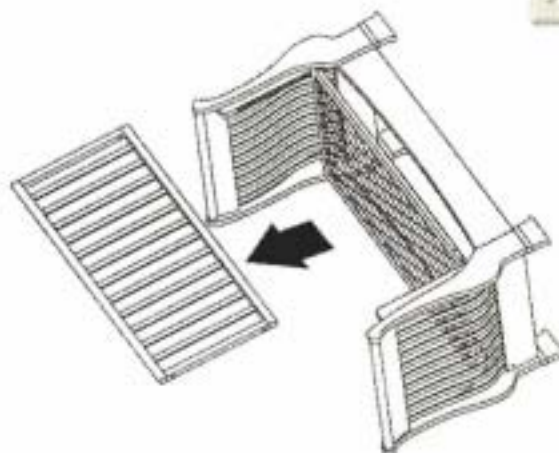

**3** Remove the stationary side supports.

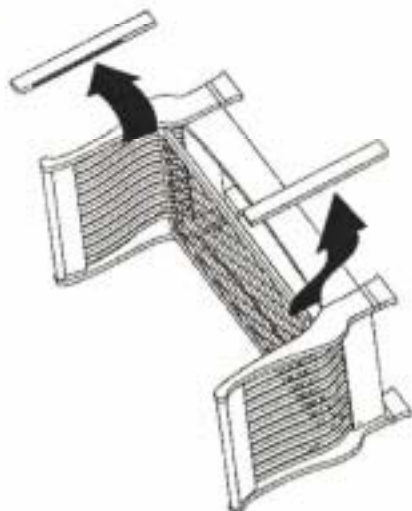

Finally re-turn the structure onto its feet; it has become a junior bed.



**USE THE SHORT BOLTS 6x10 TO COVER THE HOLES ON THE POSTS.**

