



Pali Design, Inc.

1525 Hymus Boul.
 Dorval, QC
 H9P-1J5 Canada
 Phone: 1-514-421-0309

customerservice@pali-design.com

www.pali-design.com



Assembly Instruction

Volterra Forever Crib



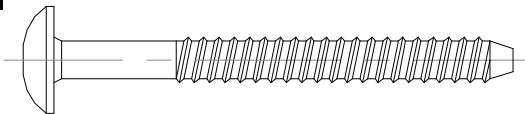
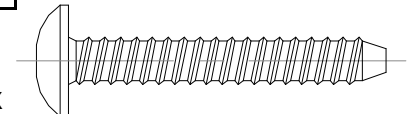
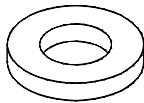
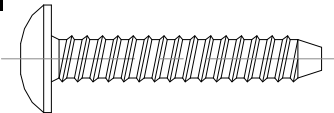
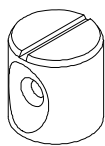

This crib has been designed for your child's comfort and your convenience. Quality material and workmanship have gone into this crib which will provide a sound and comfortable bed for your baby if properly assembled and maintained. For the security of your child and your own peace of mind be sure to follow the assembly instructions exactly. Adult assembly is required. A periodic check should be made of all bolts and screws, which should be tightened if needed. Moisture and heat are harmful to the finish; for this reason use extreme caution when vaporizer is in use. The vapor steam should always be aimed away from the crib as well as away from other wood furniture. Some types of soft plastic toys could damage the finish when placed against it.

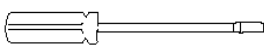
Hardware Parts List

A Round Allenhead Bolt  4x	B Round Allenhead Bolt  4x	C Washer  4x	
D Round Allenhead Bolt  8x	E KD Nut  4x	F Allen Wrench  1x	Tools Needed for Assembly: 

<p>INSTRUCTION LEAFLET</p> <p><i>Important, keep for future reference. Read carefully.</i></p> <p><i>Adult assembly is required.</i></p>	<p>IMPORTANT: In order to properly assemble the crib, carry out the operations in the order specified. Failure to assemble the crib in the manner recommended could make the crib hazardous. Carefully remove and lay out all parts. Familiarize yourself with all diagrams to facilitate the assembly of your crib. Check parts enclosed in hardware bag with the HARDWARE PARTS LIST to be sure all are included and quantities are correct.</p>
---	--

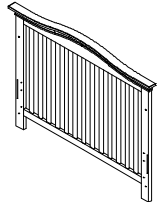
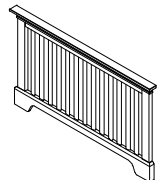
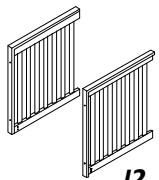
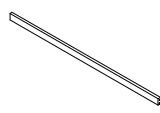
Crib Parts List:

G Headboard  1x	H Footboard  1x	J End Panel  J1 2x J2	K Stabilizer Bar  1x	L Mattress Support  1x
---	---	---	---	--

CRIB Assembling Crib

- This crib has three mattress support positions for use in your baby's first months.
- As soon as baby starts to sit up you must use the lowest mattress support position.
- To assemble the crib with the high mattress support position see Step 1.
- When using the crib as a toddler bed, remove the Footboard and the lower mattress support position must be used.

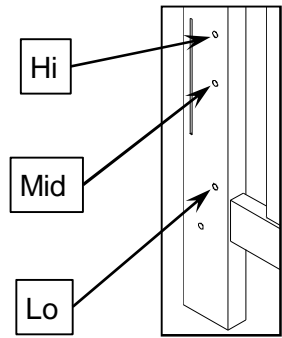

CRIB Step 1 Attaching the Sides (End Panels)

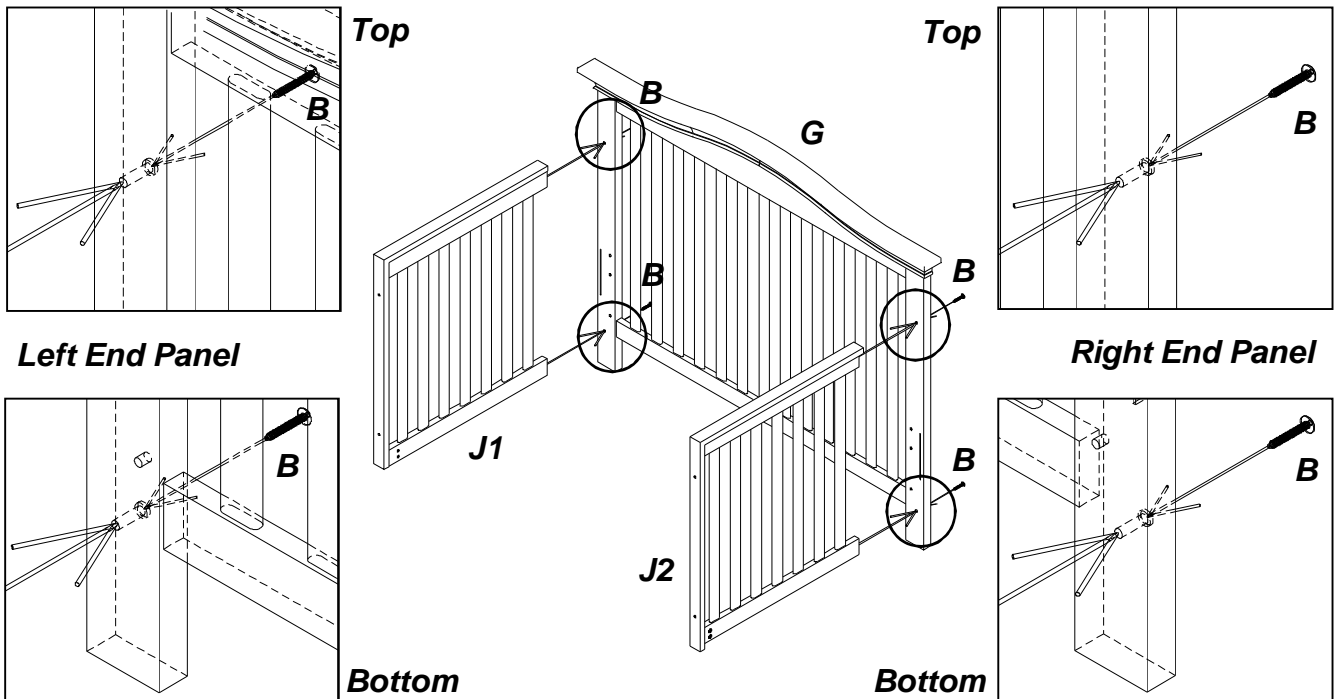

CRIB Step 2 Attaching the Stabilizer Bar

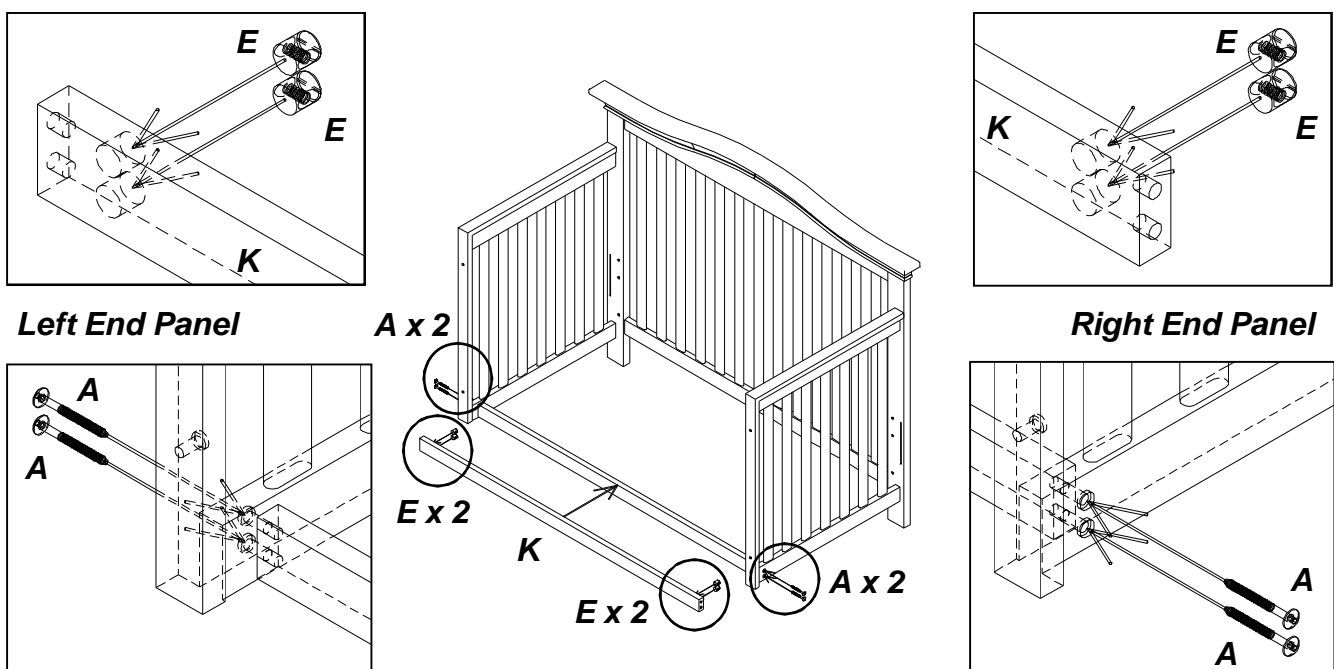

CRIB Step **3** Attaching the Footboard

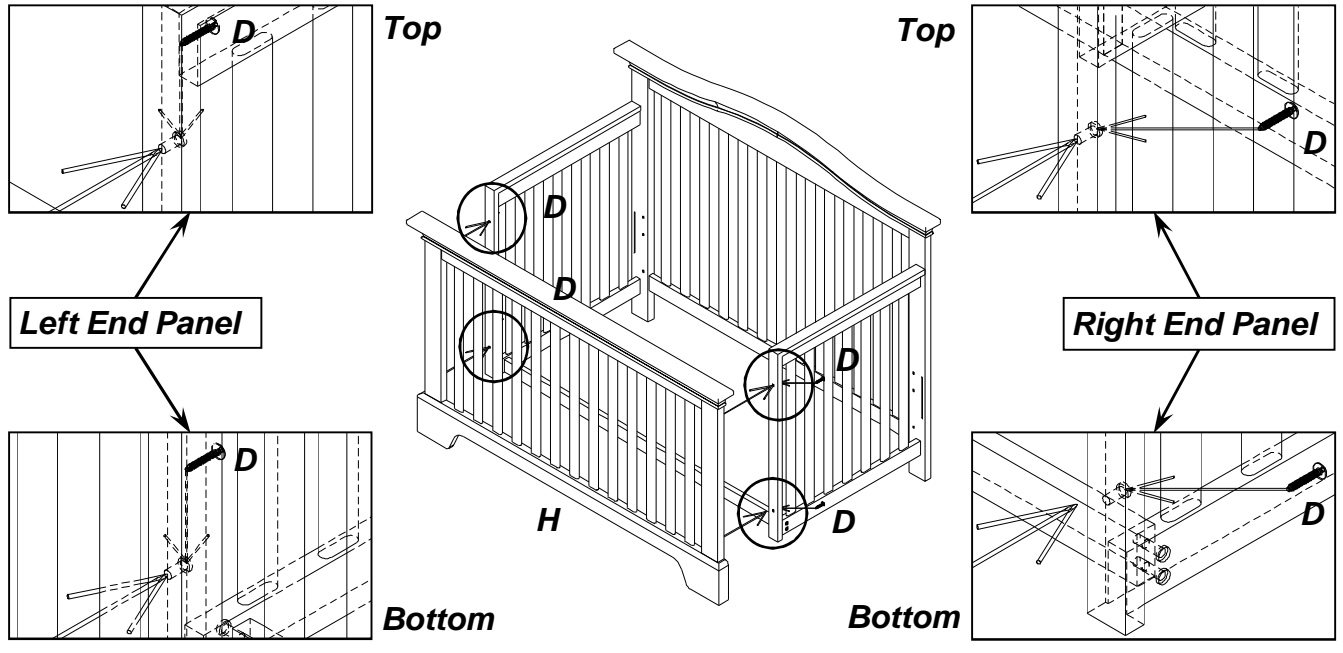

CRIB Step **4** Attaching the Mattress Support

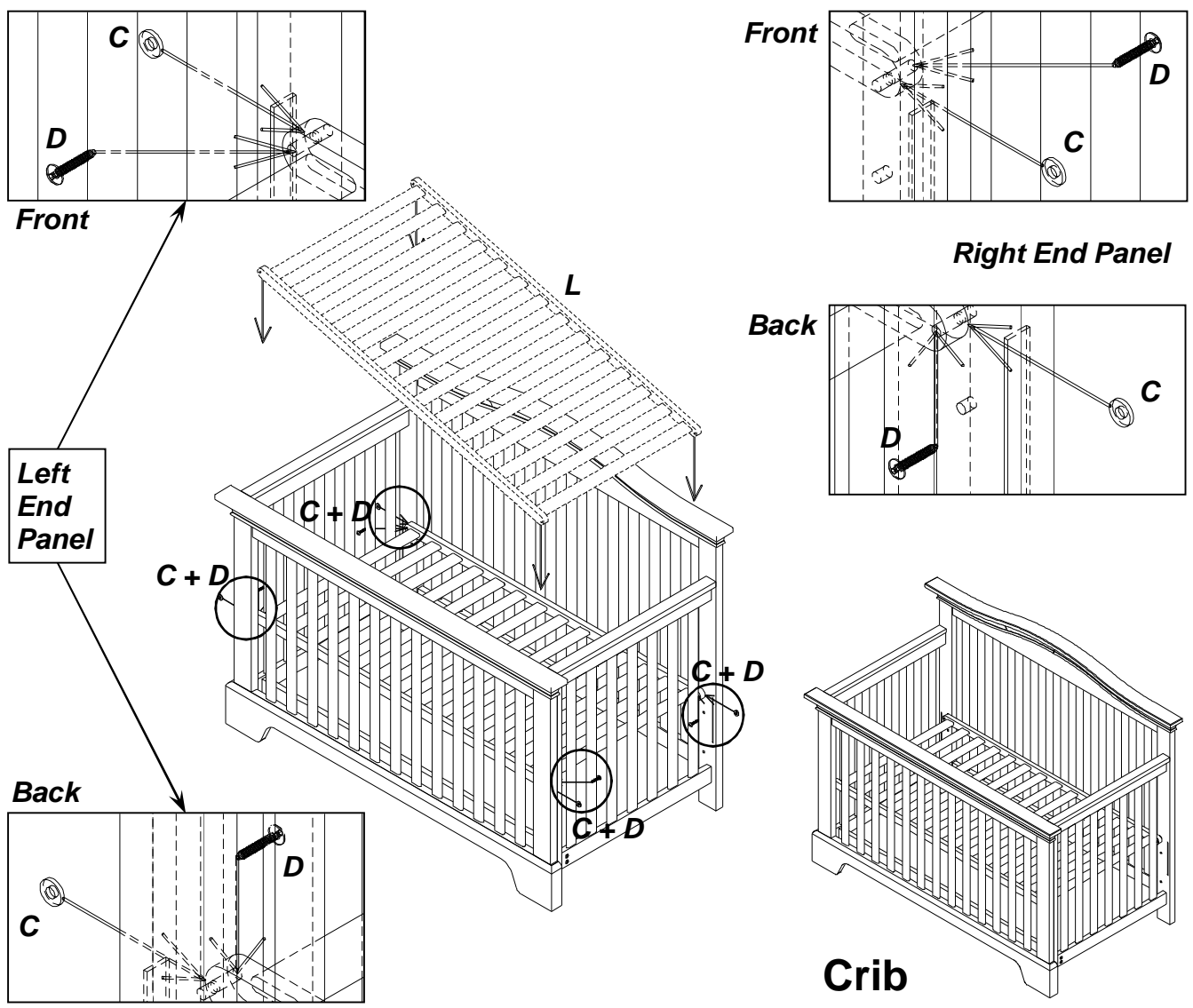

Transforming Crib into a Toddler Bed and a Child's Day Bed

(1215 Volterra Toddler Rail Kit sold separately)

Toddler
Bed

Step
1

Left End Panel

Right End Panel

Front

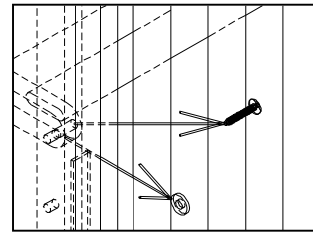
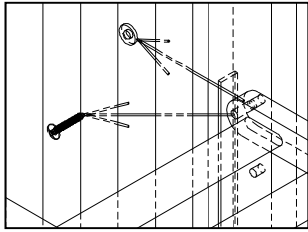

Front

Back

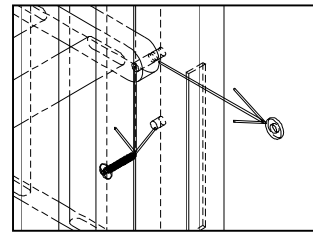
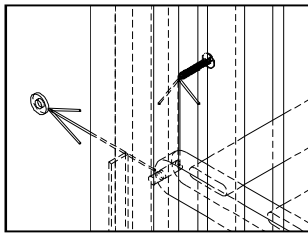

Back

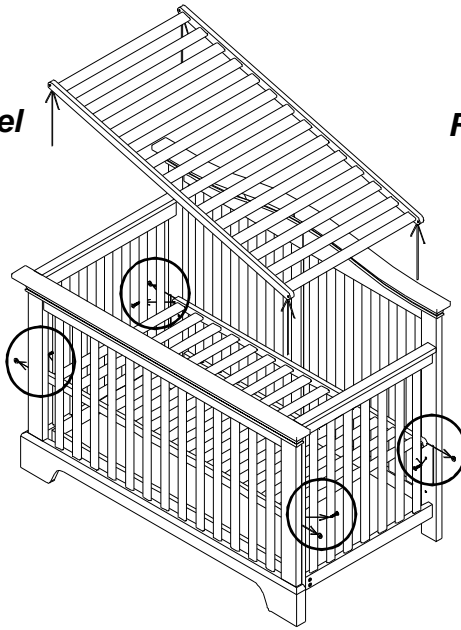

Toddler
Bed

Step
2

Top

Top

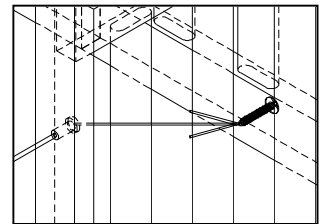
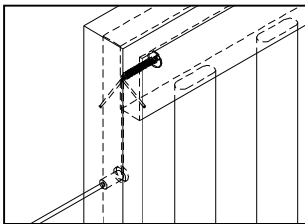

Left End Panel

Right End Panel

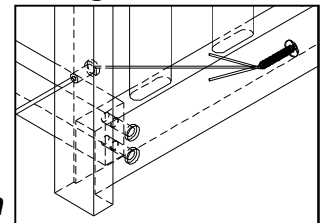
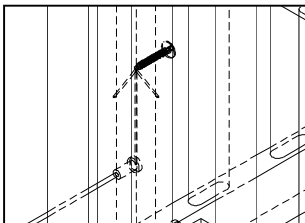

Bottom

Bottom

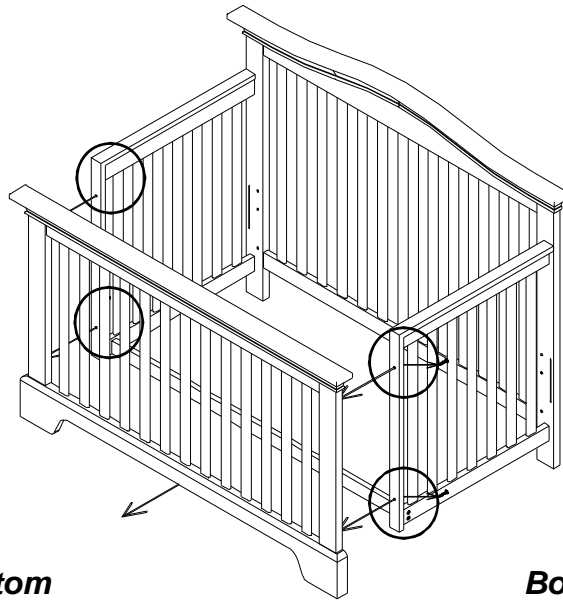

Toddler
Bed

Step
3

Top

Post

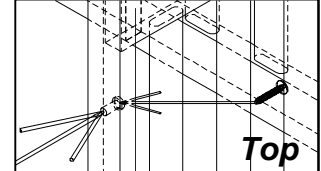

Top

Left End Panel

Right End Panel

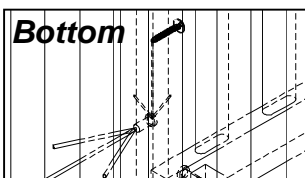

Bottom

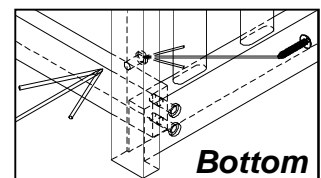

Bottom

Note: Bolts used to attach toddler bed posts are the same bolts that were removed when detaching the footboard.

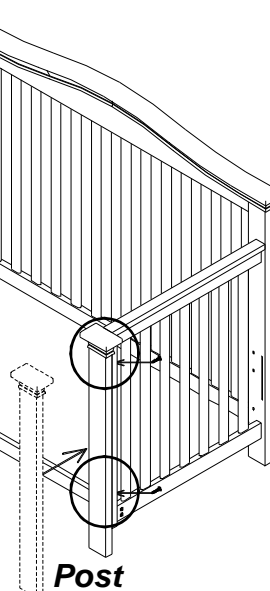

Post

Toddler Bed

Step 4

Note: Bolts in this step are from the 1215 Volterra Toddler Rail hardware pack.

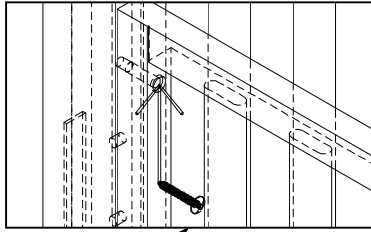

Top

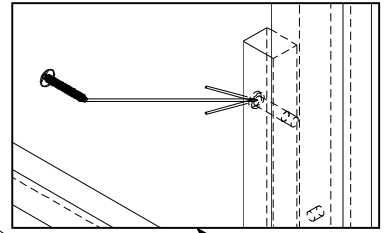

Top

Left End Panel

Right End Panel

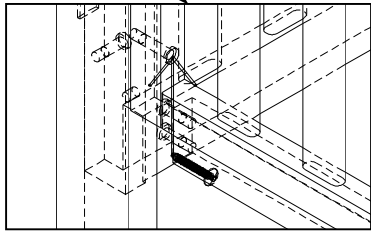

Bottom

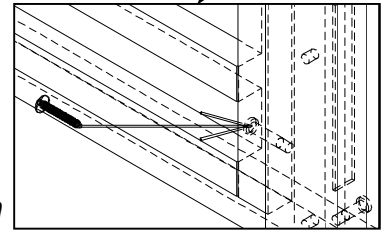

Bottom

Toddler Bed

Step 5

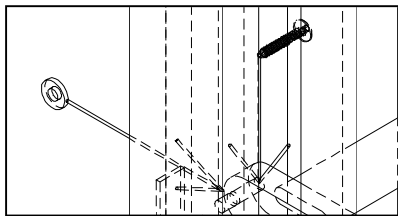

Front

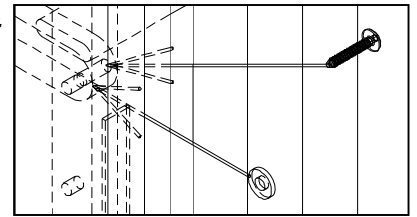

Front

Right End Panel

Left End Panel

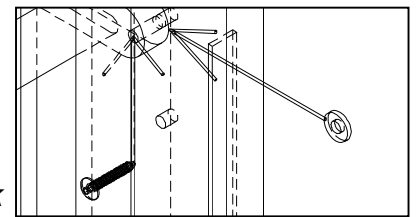

Back

Back

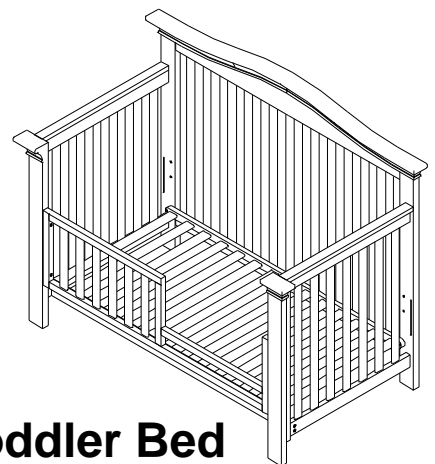
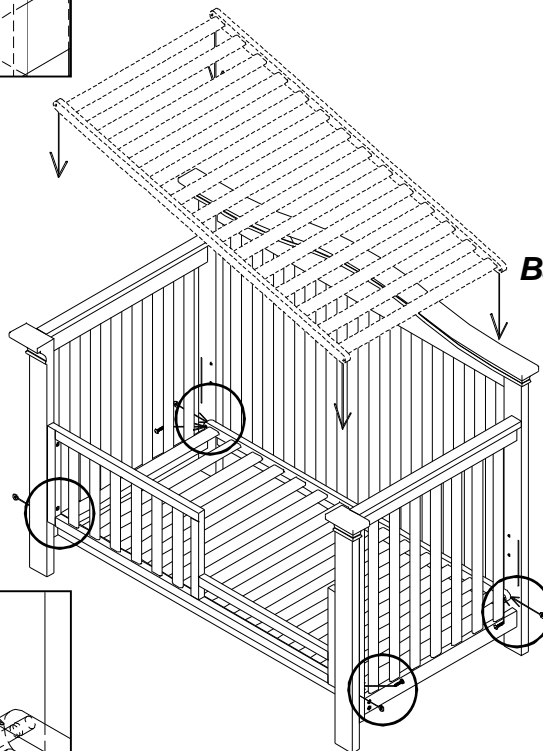
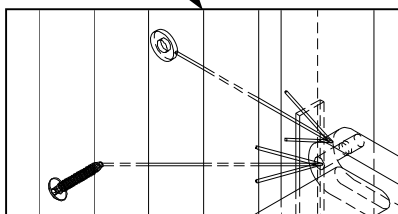

Toddler Bed

Child's Day Bed

Step 1

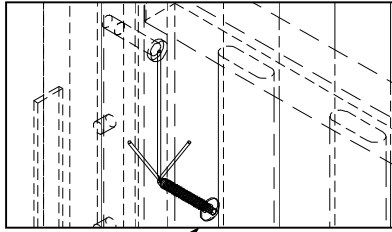

Top

Left End Panel

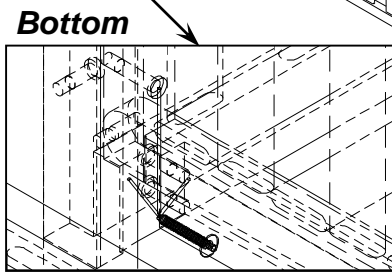

Bottom

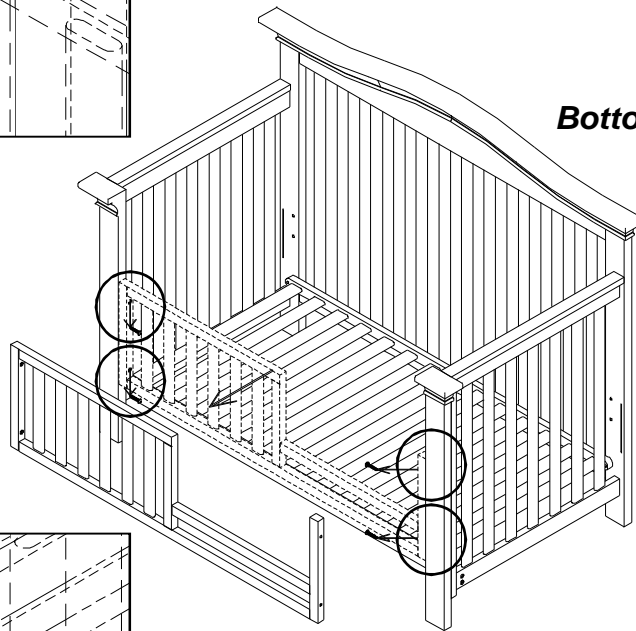

Top

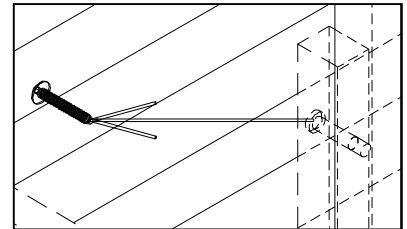

Right End Panel

Bottom

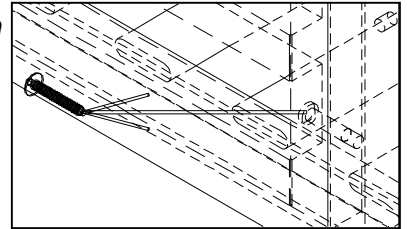

Child's Day Bed



WARNING STATEMENTS

- Read all instructions before assembling crib. **Keep instructions for future use.**
- Failure to follow these warnings and the assembly instructions could result in serious injury or death.
- Never use plastic shipping bags or other plastic film as mattress covers because they can cause suffocation.
- Infants can suffocate in gaps between crib sides and a mattress that is too small.
- Infants can suffocate on soft bedding. Never add a pillow, comforter or padding.
- To reduce the risk of SIDS, pediatricians recommend healthy infants to be placed on their backs to sleep, unless otherwise advised by your physician.
- Strings can cause strangulation! Do not place items with a string around a child's neck, such as hood strings or pacifier cords. Do not suspend strings over a crib or attach strings to toys.
- To help prevent strangulation tighten all fasteners. A child can trap parts of the body or clothing on loose fasteners.
- **DO NOT** place crib near window where cords from blinds or drapes may strangle a child.

- When child is able to pull to a standing position, set mattress to lowest position and remove bumper pads, large toys and other objects that could serve as steps for climbing out.
- When child is able to climb out or reaches the height of 35 in. (90 cm), the crib shall no longer be used.
- Check this product for damaged hardware, loose joints, missing parts or sharp edges before and after assembly and frequently during use. DO NOT use crib if any parts are missing, damaged or broken. Contact Pali for replacement parts and instructional literature if needed. DO NOT substitute parts.
- DO NOT use a water mattress.
- If refinishing, use a non-toxic finish specified for children's products.
- CAUTION: ANY MATTRESS USED IN THIS CRIB MUST BE AT LEAST 27 1/4 IN. (69 CM) BY 51 5/8 IN. (131 CM) WITH A THICKNESS NOT EXCEEDING 6 IN. (15 CM)



TODDLER BED WARNING STATEMENTS

- Failure to follow these warnings and assembly instructions could result in serious injury or death from entrapment or strangulation.
- DO NOT place bed near window where cords from blinds or drapes may strangle a child.
- The mattress intended for use on the bed shall be a full-size crib mattress having minimum dimensions of 51 5/8 in. (1310mm) in length, 27 1/4 in. (690mm) in width and 4 in. (100mm) in thickness.
- Strings can cause strangulation! Do not place items with a string, cord or ribbon around a child's neck, such as hood strings or pacifier cords. Do not suspend strings over a toddler bed for any reason or attach strings to toys.
- The minimum age of the intended user shall not be less than 15 months and the maximum weight shall not be greater than 50 lbs. (22.7kg).
- The guardrail provided must be used to avoid the formation of a gap between the mattress and the bed that could cause an entrapment.



CARE AND MAINTENANCE

- When cleaning your crib, please use a non-toxic, non-abrasive cleaner. Mix a solution of water with a small amount of mild dishwashing liquid. Apply to crib surface with a soft, damp cloth lightly dampened in solution. After cleaning, dry completely with a soft, dry cloth.
- When storing crib use caution as extreme changes in temperature or humidity can compromise the crib making it extremely dangerous to your child.